



OTCW-FXM

For FX-MAXX Control
on Chilled Water Air Conditioning Systems



OPERATOR'S MANUAL

Technicold Marine Systems | www.technicold.com



Technicold by Northern Lights

1419 W. Newport Center Drive
Deerfield Beach, FL 33442

Tel: (954) 421-1717

Fax: (954) 421-1712

Copyright ©2012, Northern Lights, Inc.
All rights reserved. Northern Lights, Technicold,
the Northern Lights logo, and the Technicold logo are trade-
marks of Northern Lights, Inc.

Printed in U.S.A.
PART NO.: OTCW-FXM 04/12



OPERATOR'S MANUAL

for FX-MAXX Air Handler Control

*Read this operator's manual thoroughly before starting to operate your equipment.
This manual contains information you will need to run and service your new unit.*

Table of Contents

INTRODUCTION	2
BASIC OPERATION	3
DESCRIPTION OF OPERATION	4
OPERATOR CONTROLS AND DISPLAY PANEL	5 - 7
DUAL BUTTON FUNCTIONS	7
MODES OF OPERATION	7
MOISTURE MODE	8
FAN MODES	8
PROGRAM MODE	8
ENTERING THE PROGRAM MODE	9
DEFAULT PROGRAM TABLE	10
PROGRAMMING	11 - 13
WATER VALVE OPERATION	13
SPECIAL HARDWARE INSTRUCTIONS.....	14
AMBIENT AIR TEMPERATURE TO WATER TEMPERATURE DIFFERENTIAL	13
SPECIFICATIONS	14
DIGITAL CONTROL DIMENSIONS.....	15
WIRING DIAGRAM	16
INSTALLATION OVERVIEW	17
BASIC SYSTEM STARTUP TROUBLESHOOTING	18
STUCK BUTTON CHART.....	19
DISPLAY CABLE TROUBLESHOOTING GUIDE	19
WARRANTY INFORMATION	20-21
FX-MAXX CONTROL WITH UV LAMP	22
FX-MAXX DISPLAY WITH FX-2 CIRCUIT BOARD	23

NOTES: All items labeled COMP should be considered Electric Heater applications.
When the Alternate Air Sensor is required the Outside Air Sensor is not available.

Proprietary Information

This publication is the property of Northern Lights, Inc.

It may not be reproduced in whole or in part without the written permission of Northern Lights, Inc.

© Northern Lights, Inc. All right reserved.

Every precaution has been taken in the preparation of this manual to insure its accuracy. However, Technicold by Northern Lights assumes no responsibility for errors and omissions. Neither is any liability assumed for damages resulting from the use of this product and information contained herein.

Litho U.S.A. Publication number OTCW-FXM 04/12

INTRODUCTION

The Fx-Maxx Control is designed for use with Chilled Water Air Conditioning Systems. Fx-Maxx has a universal power supply that operates on 115, 230, 50 or 60 Hz AC power. Fx-Maxx Air Handler Control includes the following standard and optional features:

STANDARD FEATURES

- Paintable Face Plate Cover with recess for matching wall covering insert. (Hideaway Display Only)
- User friendly 6 button display panel requires no manual for basic operation.
- Five volt logic and micro controller located in the display.
- 3-digit 7-segment display indicates readings in °Fahrenheit or °Celsius.
- Room temperature sensor is placed in the display panel.
- Automatic fan speed reduction in cooling as set point is approached.
- Automatic fan speed increased in heating as set point is approached.
- Six [6] manual fan speeds.
- 18 programmable parameters for custom installations.
- Moisture Mode for controlling relative humidity when the boat is unoccupied.
- Universal 115/230 VAC power supply.
- Nonvolatile memory retains settings without batteries.
- Programmable display brightness control for night use.

OPTIONAL FEATURES

The following optional items can be added by plugging the device into the appropriate jack and making the necessary programming changes.

Outside air temperature sensor.

Alternate air temperature sensor.

Optional Electric Heaters and UV lamps can also be added to the control board terminal strip.

This manual is intended to provide information necessary to insure proper installation and operation of the Fx-Maxx Air Handler Control. Poor installation and MISUNDERSTOOD operating parameters will result in unsatisfactory performance and possible premature failure of the control.

Read This Manual Completely Before Proceeding!

If you require assistance prior to or during the installation of the Fx-Maxx Air Handler Control call Technicold by Northern Lights at 945-421-1717 or Fax your questions to Technicold at 954-421-1712. Our service department email is: info@technicold.com

Incorrect installation, neglect and system abuse are not covered under Technicold's warranty policy. See page 20 & 21 for details on Technicold by Northern Lights' limited warranty policy.

NOTE: *In order to continually improve the Fx-Maxx Air Handler Control, we reserve the right to change this products' basic operation, specifications and design criteria without prior notice.*

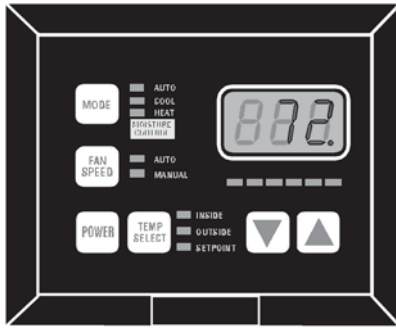
BASIC OPERATION

POWER BUTTON Press the power button once to toggle the unit to the on mode. Press the power button again to toggle the unit to the off mode.

FAN BUTTON Press and release the **fan button** to advance from auto to manual fan. Press and release to increase the manual fan speeds, 1 through 6. Press and release again returns to the auto fan mode. The selected fan mode is indicated by the Auto and Manual fan LED's

UP BUTTON Momentarily press and the set point will appear in the temperature display. The set point increases one degree each time the up button is pressed and released.

DOWN BUTTON Momentarily press and release to display the set point. The set point is decreased one degree each time the down button is pressed and released.

MODE BUTTON The mode button is used to select one of 4 Operating Modes. Press and release to advance to the next mode. Continue to press and release until the desired Operating Mode is reached. The mode selected is indicated by the Mode LED.

HEAT MODE LED The heat mode LED is lit when Heating is selected.

COOL MODE LED The cool mode LED is lit when the Cooling is selected.

AUTO LED The auto LED is lit when the Automatic Heating or Cooling Mode is selected. The control will automatically switch to heating or cooling when this mode is selected.

MOISTURE CONTROL LED The moisture LED is lit when the Moisture Control is selected.

TEMP SELECT BUTTON Press and release to view inside air temperature, outside air temperature or set point. The appropriate LED will be lit indicating which temperature is displayed.

THREE DIGIT DISPLAY The room temperature is displayed whenever the control is turned on. The display provides a readout of the inside ambient air temperature and the set point.

AUTO FAN LED The auto fan LED is illuminated when the automatic fan speed operation has been selected.

MANUAL FAN LED The manual fan LED is lit when a manual fan speed is selected.

FAN SPEED BAR GRAPH There are six [6] individual fan speed LED's. Each LED represents one [1] fan speed. Low fan [1] is indicated by illuminating the first LED. High fan speed is indicated by illuminating all six [6] LED's.

WATER VALVE STATUS LED The system operating status [Water Valve Open] is indicated by turning **On** the right most decimal point in the 3 Digit Display. The same LED indicates when the electric heater is on.

DESCRIPTION OF OPERATION - OVERVIEW

Fx-Maxx is a user friendly, easy to operate, programmable temperature control.

Press the POWER ON/OFF button once to engage the system. The display indicates room temperature when the system is on and the display is blank when the system is off.

Press and release the Mode Button until the desired Mode LED is illuminated.

Set the room temperature by pressing the up or down button. The set point can be viewed by momentarily pressing and releasing the up or down button or pressing the temp select button until the setpoint LED is illuminated.

Fan speed operation is automatic. The fan speed decreases as room temperature is approached in cooling mode. The fan speed increases as room temperature is approached in heating mode. The fan speed in heating mode can be programmed to operate the same as cooling mode by changing parameter P-12. The fan will now operate at low speed when set point is satisfied in cooling and heating mode. Manual fan speeds can be selected by pressing the Fan Speed Button and selecting the desired fan speed. The fan will operate at the speed selected and will not change speeds with room temperature.

The fan can be programmed to cycle on and off with the Heating and Cooling demand, but is not recommended. Cycle fan off feature when demand is satisfied cannot be selected when using a Hideaway display, nor should it be selected when using an Alternate Air Sensor. Normally the automatic fan speed operation is reversed in the heating mode, however, the fan speeds can be programmed to operate the same as in the cooling mode.

NORMAL HEATING OR COOLING CYCLE

When heating or cooling is called for the water valve switches to the appropriate mode. Four [4] seconds later the automatic fan control adjusts the fan to the proper speed. When the demand is satisfied, the water valve cycles off and the fan returns to low speed. If cooling is required, the water valve will not open unless adequate cooling water is available. The fan will remain in low speed until adequate cooling water is available. If heating is required the valve will not open unless adequate heating water is available. The fan remains in low speed until adequate heating water is available. The water temperature can be viewed by simultaneously pressing the Up and Down Buttons while in the On Mode. Heat will be supplied when no heating water is available if the Optional Electric Heater [Electric heating element] has been installed and programmed.

While in a Heating or Cooling Mode the controller will maintain a two degrees Fahrenheit (2 °F) temperature variation. A four degree swing is required to cause the unit to shift to the opposite mode. Once in a new mode, Heating or Cooling, Fx-Maxx Air Handler Control will maintain a two degree differential.

MOISTURE MODE

While in the on mode, press the Mode Button until the Moisture Control LED is lit. The first cycle will start in 1 minute. Every 4 hours, the fan is started and air circulated for 30 minutes. During this time the air temperature is sampled and entered into memory. The cooling cycle is started and continues until the temperature is lowered 2 ° F from the sampled temperature. The set point temperature is disabled during this function and the control operates using the sampled ambient temperature. The system is allowed a maximum of one hour running time to reach the desired temperature. Four hours after the temperature is satisfied or the Cooling Mode times out, the cycle is repeated. During the humidity cycle the Valve LED is lit while the system is Cooling.

Note: The Moisture Mode should only be used when the boat is left unoccupied. Its purpose is to reduce the humidity levels inside the vessel not to maintain a temperature comfort level for living conditions. The benefits to this feature are; constant de-humidification of the vessel at a predetermined schedule; reduced maintenance on the raw water strainer; minimal run times to save on power consumption.

Fx-Maxx Air Handler Control has nonvolatile memory which requires no batteries or any form of backup power. All operating and programming parameters are entered into nonvolatile memory instantly and are retained indefinitely. When power is lost the operating parameters are retained indefinitely. When power is restored, the control resumes operating at the last settings of the display.

OPERATOR CONTROLS AND DISPLAY PANEL

Refer to figure 1 for the buttons locations and display functions listed on the following pages.

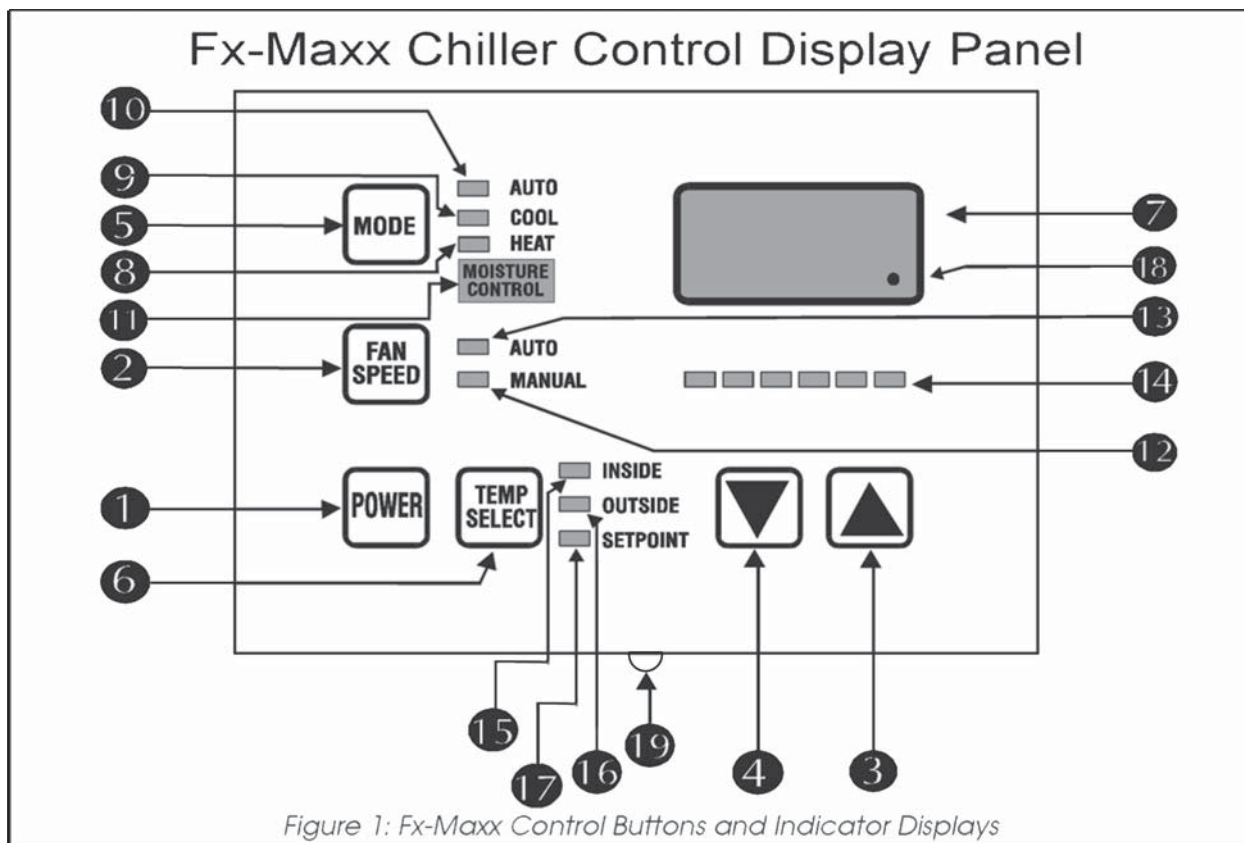

- 1. POWER BUTTON** The power button is used to toggle between the on and off modes. Press the power button once to toggle the unit to the on mode. Press the power button again to toggle to the off mode.
- 2. FAN SPEED BUTTON** The fan speed button is used to switch between Auto and Manual Fan Speeds. Pressing and releasing the Fan Speed Button once toggles the fan mode as indicated by the Fan LED indicator lamps. Press and release the fan speed button until the desired Automatic [A] or Manual Fan Speed [1 through 6] is selected.
- 3. UP BUTTON** Momentarily press the up button and the set point will appear in the temperature display. Press and release the up button to increase the set point one degree. The set point is increased by one degree each time the up button is pressed and released. The highest set point allowed is 85 ° F. The up button is used with the down button to display the Water In temperature when the control is on (See dual button function on page 7). The up button is also used to increase program values in the program mode (See page 9).

OPERATOR CONTROLS AND DISPLAY PANEL

4. **DOWN BUTTON** Momentarily press and release the down button to display the set point. Press and release the down button to decrease the set point. The set point is decreased one degree each time the down button is pressed and released. The lowest set point allowed is 55 ° Fahrenheit. The down button is used in conjunction with the up button to display Water In temperature when the control is on (see dual button function on page 7). The down button is also used to reduce program values in the program mode.
5. **MODE BUTTON** The mode button is used to select one of the four operating modes. Press and release the mode button and the Fx-Maxx Air Handler Control will advance to the next mode. Continue to press and release the Mode button until the desired operating mode is reached. The mode selected is indicated by the Mode LED, i.e., Cool, Heat, Automatic or Moisture Mode.
6. **TEMP SELECT BUTTON** Press and release the **Temp Mode Button** to view inside air temperature, outside air temperature or the set point. The appropriate LED, Inside, Outside or Set Point will be lit indicating which temperature is being displayed. If no outside air sensor is installed three [3] dashes will appear in the Three Digit Display.
7. **THREE DIGIT SEVEN SEGMENT DISPLAY** The inside air temperature is displayed in the window whenever the control is turned on. The display also indicates program information, fault codes, set point and outside air temperature when the **optional outside air sensor** is installed. The display momentarily indicates the **set point** when the **up** or **down** button is pressed. When the control resumes operation after a power interruption all the display LEDs will turn on for one second. This is a normal operating condition and is referred to as "Power On Reset".
8. **HEAT MODE LED** The heat mode LED will be lit when the Heat Mode has been selected. The heat mode LED is also lit when the optional electric heat is installed and the heat mode is selected. Electric heater status, on or off, is indicated by the right side decimal point [18].
9. **COOL MODE LED** The cool mode LED will be lit when the Cooling Mode has been selected
10. **AUTO LED** The auto LED is lit when the automatic heating or cooling mode has been selected. The control will automatically switch to heating or cooling when this mode is selected.
11. **MOISTURE CONTROL LED** The moisture mode LED is lit when the Moisture Control has been selected. **This mode is used to control humidity during periods when the vessel is unoccupied.**
12. **MANUAL FAN LED** The manual fan LED will be lit when one of six manual fan speeds has been selected.
13. **AUTO FAN LED** The auto fan LED is illuminated when automatic fan speed operation has been selected.
14. **FAN SPEED BAR GRAPH** There are six [6] individual fan speed LED's in the Fan Speed Bar Graph. Each LED represents one [1] fan speed. Low fan speed [1] is indicated by illuminating the first LED. High fan speed is indicated by illuminating all six [6] LED's. Any of the six [6] fan speeds available are displayed by illuminating the appropriate LED's.
15. **INSIDE LED** The inside LED is lit when the inside air temperature is being displayed.

OPERATOR CONTROLS AND DISPLAY PANEL

16. **OUTSIDE LED** The outside LED is turned on when the outside temperature is displayed.
17. **SET POINT LED** The set point LED is turned on when the set point is displayed.
18. **VALVE / HEATER INDICATOR** The system operating status [Water Valve or Electric Heater On/Off] is indicated by turning On or Off the right most decimal point in the 3 Digit Display.
19. **DISPLAY AIR SENSOR** An air sensor is located on the bottom edge of the display. When an alternate air sensor is plugged into the control board, the display sensor is automatically disabled. Removing the alternate air sensor from the control board automatically enables the display sensor.

DUAL BUTTON FUNCTIONS

Up & Down Buttons Simultaneously Press the Up and Down buttons, while in the On Mode, to view the circulation water inlet temperature.

Simultaneously Press the UP & Down Buttons while in the program mode to set new custom programming defaults.

MODES OF OPERATION

Off Mode

When the Fx-Maxx Air Handler Control is in the off mode, all control outputs are turned off. Program parameters and user settings are saved in nonvolatile memory. The program mode can only be accessed from the off mode.

On Mode

When the control is in the on mode, power will be supplied to the appropriate control outputs and the display will indicate the current state of operation. The operating and program parameters resume based on those stored the last time the unit was operating.

Cool Only Mode

When Cool LED is on, only the cooling systems are selected and operated as required. When the temperature drops below the set point, the system will not automatically switch to the heating mode. Cooling only is available for customers that do not want automatic cooling and heating operation.

Heating Only Mode

When the Heat LED is on, only the heating systems are selected and operated as required. Should the temperature rise above the set point, the system will not automatically switch to the cooling mode. Heating only is supplied for customers that require the system to not automatically switch from the heating to the cooling mode.

Automatic Mode

When the Automatic LED is on, both heating and cooling are supplied as required. The heat and cool LEDs will be lit according to the mode required. When the system requires the water valve to be turned on for heating or cooling the water valve indicator (decimal point), will turn on when the valve is on and will turn off when the valve is off. This also applies to the electric heater if installed.

Temperature in a given mode will be maintained at two degrees Fahrenheit (2 ° F), however, a four degree difference is required to allow the control to change modes. Once in a new mode, the temperature will remain within two degrees Fahrenheit (2 ° F) of the set point.

MOISTURE MODE

While in the **On mode**, press the Mode Button until the Moisture Mode LED is illuminated. The first cycle will start in 1 minute. Every 4 hours, the fan is started and air is circulated for 30 minutes. During this time the air temperature is sampled and entered into memory. The cooling cycle is started and continues until the temperature is lowered 2 ° F. The system is allowed a maximum of one hour running time to reach the desired temperature. Four (4) hours after the temperature is satisfied or the one hour timer runs out the cycle is repeated. During the humidity cycle the Water Valve LED is lit while the water valve is turned on and the system is cooling.

FAN MODE

Automatic Fan Speeds

Fx-Maxx has six automatic fan speeds available. Speed six is high, three is medium and one is low or the slowest speed. Automatic fan mode allows the Fx-Maxx to determine the required fan speed based on room temperature. The closer the room temperature is to the set point, the slower the fan will run. This permits a balance between the most efficient temperature control and slower, quieter fan speeds. Automatic fan operation is the factory default, however, manual fan speed control is available.

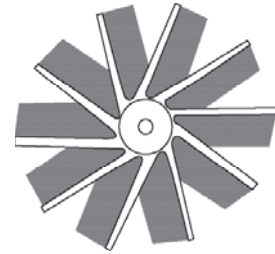

Manual Fan Speeds

Six (6) is the fastest and one (1) represents the slowest fan speed. Manual fan mode allows the user to select and maintain the desired fan speed manually. When a manual fan speed has been selected, the fan speed bar graph will indicate the speed selected by the number of LED's lit. Select speed 3, for example, and the first 3 LEDs in the fan bar graph will turn on. Manual Fan Mode is sometimes preferred when room temperature is constant or changing due to varying heat loads.

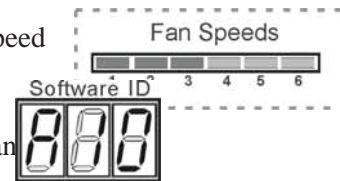

PROGRAM MODE

Program Mode Overview

The program mode is used to adjust the systems operating parameters to suit the particular needs of individual users. The program mode is also used to tailor the air-conditioning system for the most efficient operation within an installation. Installation variables such as, ducting, sensor location and system layout effect the perceived operation of the overall system. The program mode allows the system to operate as efficiently as possible under all conditions.

Fx-Maxx Air Handler Control is shipped with factory default settings which are stored in permanent memory and can be recalled at any time.

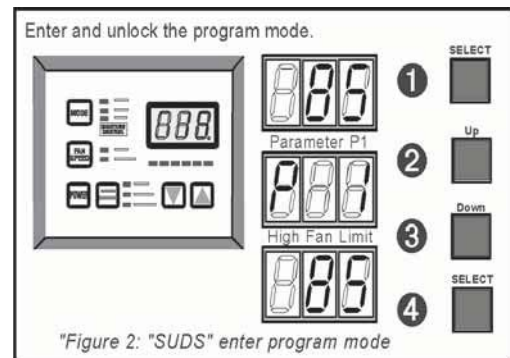

WARNING

Severe electrical disturbances can sometimes upset the Fx-Maxx operating sequences. Operator confusion related to program parameters can also cause, what seem to be, operational problems. Whenever there is any doubt as to the proper operation of the controller, Factory Default Parameters should be Re-initialized.

ENTERING PROGRAM MODE

The program mode can only be entered from the **Off Mode**. From the Off Mode and in the following order, press the **Select, Up, Down** and the **Select** buttons ["**SUDS**"]. These buttons have to be pressed and released in the order given. The numerals "85" which represent the high fan limit, appears in the display. The "85" is followed by the characters "P 1" followed again by the parameter setting ["85"]. **P 1** represents the first programmable parameter. The Fx-Maxx Air Handler Control is now in the program mode. Exit the program mode, to the **off mode**, by pressing and releasing the **power** button.

NOTE: The control will exit the program mode and return to the **Off Mode** if no programming is attempted for one (1) minute.

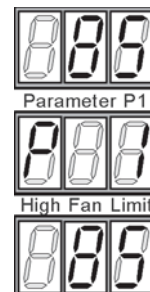

Restore Memorized Default Settings

IMPORTANT! The memorized default settings can be **restored** by entering the program mode and setting P-16 to **rSt**. Exit the program mode and the software version number appears in the display. The **memorized default settings** are restored and the Fx-Maxx Air Handler Control returns to the **off mode**. The software version number is always displayed when you exit the program mode.



USING THE PROGRAM MODE

Increment from one **program parameter** to the next by pressing the **Mode Button** while in the **program mode**. Press and release the Mode Button to advance to the desired parameter. Use the up and down buttons to change the program parameter values. The **programmable parameters** range from P-1 through P-18.

Up and Down Buttons

The **up** and **down** buttons are used to select the data or set the desired limits for the parameter being programmed. This method is followed throughout the program mode.

Exiting the Program Mode

There are two methods to exit the program mode. Press the power button and the **Fx-Maxx Air Handler Control** will return to the **off mode**. Not pressing any buttons or attempting any program changes for sixty (60) seconds will allow the control to exit the **program mode** to the **off mode**. Any programming changes that were made while in the program mode will be memorized and put into operation when the program mode is exited and the control is returned to the on mode.

PROGRAMMABLE PARAMETERS

There are eighteen (18) programmable parameter locations with their Factory Default Settings listed in this section. The table below indicates what these parameters are, along with the permitted values and the original Factory Default Settings.

Program #	Description	Default	New	Range
P-1	High Fan Speed Limit (arbitrary units)	85		56-85
P-2	Low Fan Speed Limit (arbitrary units)	50		30-55
P-3	Unused Reserved for future options	N/A		N/A
P-4	Temperature Sensor Calibration	0		Ambient \pm 10 ^o F
P-5	Unused - Reserved for future options	N/A		N/A
P-6	Unused - Reserved for future options	N/A		N/A
P-7	Unused - Reserved for future options	N/A		N/A
P-8	Unused - Reserved for future options	N/A		N/A
P-9	Display Brightness Control	10		4 = Low 13 = Maximum
P-10	Display ^o Fahrenheit or ^o Celsius	^o F		^o F = Fahrenheit Displayed ^o C = Celsius Displayed
P-11	Outside Air Temp Sensor Only When Alt Air Sensor is Not Required	OFF		OFF = Alt Air Available On = OAT Sensor Only
P-12	Reverse Fan Speeds During Heating Mode	rEF = Reversed		nor = Normal Fan Operation rEF = Reversed Fan In Heating
P-13	Continuous Fan or Cycle Fan with Demand	con = Continuous Fan Operation		CYC = Cycle Fan On Demand con = Continuous Fan Operation
P-14	Circulation Water Heating or Electric Heat	nor = Circulation Water Heat Only		nor = Circulation Water Heat Only ELE = Electric Heater Installed
P-15	Fan Motor Type Selection - Shaded Pole or Split Capacitor	SP = Shaded Pole		SP = Shaded Pole SC = Split Cap. Fan Motor
P-16	Reset Memorized Programming Defaults	nor = Normal Operation		nor=Normal Operation rSt = Reset Defaults
P-17	Water Valve Forced Open 4 Hours to Bleed the Circulation Water System	nor = Normal Operation		nor = Normal Operation OPn = Valve Forced Open
P-18	Ambient Air to Circulation Water Temperature Differential	15 ^o F		5 ^o F to 25 ^o Fahrenheit

Should any programming problems or confusion occur, reset the Memorized Default Settings by entering the program mode and setting P-17 to rSt.

SOFTWARE IDENTIFICATION

The software version of the control is identified for one (1) second prior to the exit from the program mode. The software identification number, i.e. ("A10") will appear in the display for one second, then the control will return to the off mode.

Should there be any reason to contact Technicold about the system or programming the Fx-Maxx Air Handler Control be sure to have the software identification number available.

P-1: HIGH FAN LIMIT

The upper fan speed limit can be tailored to suit various motors and operating conditions. The high fan limit is adjusted with the system installed and operational. The range of values are 56 through 85 and represent arbitrary units*. Setting a higher number, results in a higher fan speed, setting lower numbers, lowers the high fan speed limit. Use the up and down buttons to select the desired high fan speed limit. The factory default setting is eighty-five (85).

P-2: LOW FAN LIMIT

The low fan limit determines the lowest output allowed for the low fan speed. The range of values for the low fan speeds are 30 through 55, in arbitrary units*. Use the up and down buttons to select the desired low fan speed limit. Setting a higher number, results in a higher fan speed, setting lower numbers, lowers the low fan speed limit. The factory default setting is 50.

IMPORTANT! Once the high and low fan speed limits are set, the unit will automatically readjust the remaining fan speeds to produce six (6) equally spaced in both the automatic and manual fan speeds modes.

CAUTION! In certain applications, setting the lower limit too low can cause the fan motor to stall. Check the fan operation in all six speeds once changes have been made to the lower limit. In addition, turn off the control and then back on to see if the motor will ramp up from a stationary position.

P-3: RESERVED FOR FUTURE OPTIONS

Program item P-3 is reserved for future options.

P-4: TEMPERATURE CALIBRATION

Use this feature to calibrate the air sensor within a range of \pm ten (10) °F. Enter the program mode and the ambient temperature appears in the display. Use the up and down keys to select the desired offset. The temperature in the display will increase or decrease according to the offset programmed. The factory default setting is zero.

P-5, P-6, P-7 AND P-8: RESERVED

Program items P-5, P-6, P-7 and P-8 are memory locations reserved for future options.

P-9: DISPLAY BRIGHTNESS CONTROL

The display brightness can be adjusted to suit ambient cabin lighting conditions. The allowed settings are four (4) through thirteen (13), with four (4) being the dimmest and thirteen (13) the brightest. Typically a dark cabin will require a setting of four or five. A very bright cabin will require a setting of twelve or thirteen. The factory default setting is ten (10).

P-10: FAHRENHEIT OR CELSIUS SELECTION

The unit can be programmed to display either Fahrenheit or Celsius. Programming °F selects degrees Fahrenheit and programming °C displays degrees Celsius. The factory default setting is °F, Fahrenheit. When degrees Celsius (°C) is selected the readings are displayed in tenths, i.e. 22.2 °.

P-11: OUTSIDE AIR SENSOR OPTION

The ALT AIR jack can be used as an optional outside air temperature sensor input when the alternate air sensor is not required. Plug in the outside air sensor and program P-11 on. The outside temperature can be viewed by using the Temp Select Button. Press and release the Temp Select Button until the Outside LED is lit. The outside air temperature will appear in the display while the Outside LED is lit. Note: The OAT can also be viewed by simultaneously pressing and holding the Up and Down Buttons while in the Off Mode.

NOTE: The outside air option is not available with the Hideaway control. It is also recommended that all applications use the Alternate Air Sensor feature. This will ensure accurate sensing of the cabin air and therefore more accurate control of the cabin temperature. If you intend to utilize the Outside Air feature we recommend it only be used on a limited number of Air Handler Controls.

PROGRAMMING

P-12: REVERSE AUTOMATIC FAN SPEEDS DURING HEATING

The automatic fan speeds can be reversed during the heating mode to improve heat output in cooler climates. The fan speed is decreased as the temperature spread increases. The fan will speed up as the set point is approached. Lowering the fan speed when the cabin is cold raises the supply air temperature. The fan switches to low speed when the set point is satisfied and the water valve cycles off. The fan can be programmed to operate the same as in cooling by programming P-12 nor which represents normal fan operation during normal fan operation during the heating cycle. The factory default is rEF, which reverses the automatic fan speeds during heating.

P-13: CYCLE FAN WITH THE COOLING OR HEATING DEMAND

The fan can be programmed to run continuously when the system is on or can be allowed to cycle with the demand. When cycled with demand, the fan will operate only when heating or cooling is called for. To cycle the fan with the Heating or Cooling Demand select CYC. To operate the fan continuously select con which represents continuous fan operation. The factory default is continuous fan operation [con] when the system is on.
NOTE: The fan must operate continuously when using an Alternate Air Sensor. Setting the fan to cycle with demand can cause stratification of the cabin air and affect comfort levels within.

P-14: ELECTRIC HEATING ELEMENT OPTION

Units may be equipped with Electric heating element or an in line Electric Duct Heater. Electric heating elements are used when the main Circulation water system is in the Cooling Mode and a particular cabin requires heating. The electric heating elements are also used to supplement Circulation water heating when necessary. Program P-14 for ELE to select the electric heating element Option. The factory default is nor which normally selects Circulation Water Heating and Cooling only.
IMPORTANT: Please note that option P-14 has to be programmed for ELE to allow electric heat electric heating element operation.

P-15: FAN MOTOR SELECTION

There are two basic fan motor types, shaded pole

[SP] and split capacitor [SC]. Each motor reacts differently to speed control and each motor requires different timing for optimum fan speed variation. The default setting is "SP" which selects the shaded pole motor type, however, "SC" should be selected if a split capacitor type of fan motor is used. Most manufacturers supply shaded pole type fan motors, therefore, the factory default selection is "SP".

P-16: RESET MEMORIZED DEFAULTS

The default programming parameters can be reset by entering the program mode and selecting rSt. This will restore the programmable parameters to the values selected when the system was shipped. The program parameters listed on page ten may be altered by the vendor, installing dealer or the end user. Once new defaults are entered and memorized the NEW defaults will be reset (see page 7, dual button functions). The original factory programmable parameters as listed on page ten (10) will have to be restored manually.

Why Memorize New Defaults?

Once the desired programming changes have been made and the system tests satisfactorily, your work can be saved as the new factory defaults. Your new defaults are initiated by simultaneously pressing and releasing the up and down buttons prior to exiting the program mode. New defaults can be initialized at any time by entering the program mode and following the above instructions. Once new defaults have been initialized the control will revert back to the new defaults whenever factory defaults are restored as described on page 9 of this manual.

P-17: CIRCULATION WATER VALVE FORCED OPEN

This feature allows service personnel to force the Circulation water valve open to facilitate bleeding air from the system. Selecting OPn will force the valve open for 4 hours while normal cooling and heating is maintained. The valve can be returned to normal operation any-time during the cycle by selecting nor which stands for normal operation. If no action is taken after 4 hours the control automatically puts the valve back into normal operation. If longer time is needed to bleed the system the control will need to be programmed again for another 4 hours. If no power is available to the control or in the case of a control board failure; the valve can be manually opened. There is a lever at the bottom of the valve motor, this lever can be manually moved and locked into the open position.

P-18: AMBIENT TO WATER TEMPERATURE DIFFERENTIAL

The difference between ambient air temperature and Circulation water temperature is used to control water valve opening and closing. The programmable range is five (5 ° F) through twenty-five (25 ° F) degrees Fahrenheit. Selecting fifteen (15 ° F) opens the valve when water temperature is 15 degrees less than ambient in cooling mode and fifteen degrees (15 ° F) greater than ambient in the heating mode. Figure two (2), shown on page 13, illustrates the relationship between ambient air and the Circulation water temperature using the factory default values. Careful selection of the temperature differential can fully utilize the ships heating and cooling resources.

*Arbitrary Units are values representing an operational range. They do not imply a technical value such as Amperage, Voltage, RPM or CFM; even though a change in the arbitrary units will affect those values.

WATER VALVE OPERATION

When equipped with an optional electric heater, the heater will overlap with the Circulation water heat by twenty-two degrees Fahrenheit (22 ° F). The heater will turn on when heat is required and remain on until the Circulation water temperature exceeds the ambient by twenty-two degrees Fahrenheit or until the room temperature is satisfied.

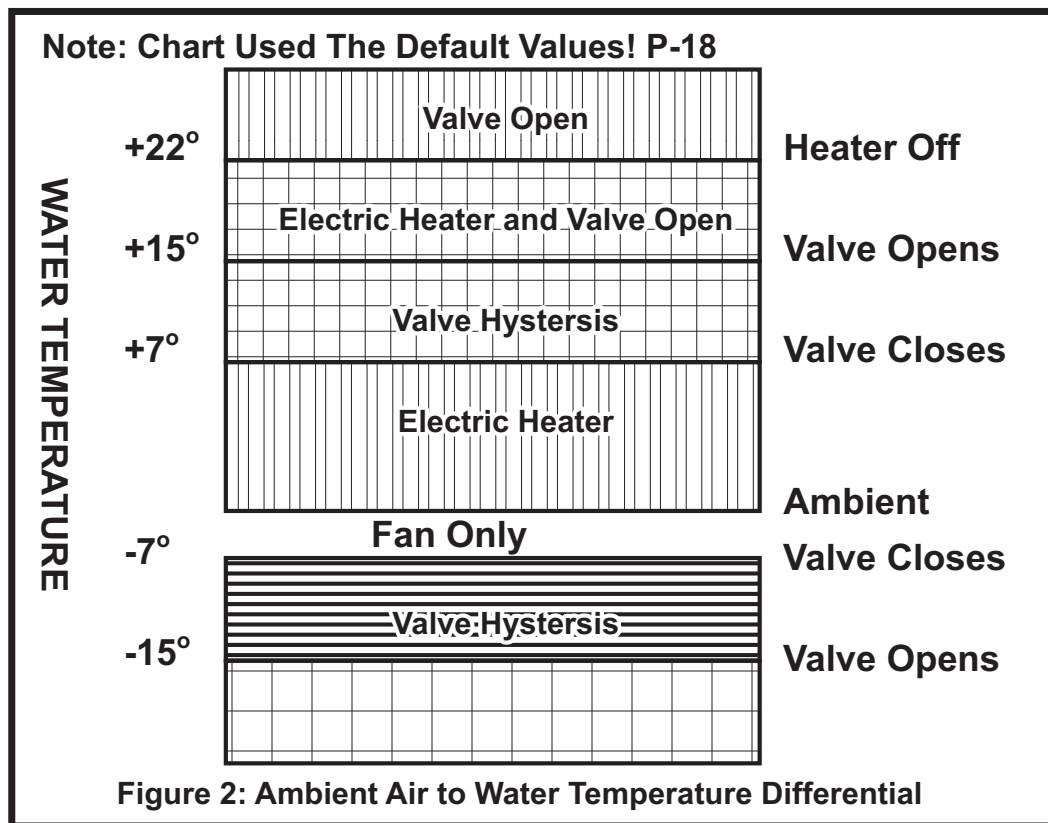

The electric heat is allowed to overlap the Circulation water heat to supplement the main heating system during very cold conditions.

SPECIAL HARDWARE INSTRUCTIONS

OUTSIDE AIR SENSOR OPTION

Install this option by plugging the Outside Air Sensor into the **Alternate Air Sensor Jack (J1)**. Program P-11 On and the feature is ready for use.

IMPORTANT!: The **OUTSIDE AIR SENSOR** option is not available when the **ALTERNATE AIR SENSOR** is installed or when using the Hideaway control.

ULTRAVIOLET GERMICIDAL LAMPS

UV – C Lamps are available for all air handlers. See the separate UV Lamp manual for installation and operation details.

ELECTRIC HEATERS

Optional Electric Heaters are available for all air handlers. See the Chilled Water manual for installation and operation details.

SPECIFICATIONS

SET POINT OPERATING RANGE.....	55 ° F TO 85 ° F
AMBIENT TEMPERATURE OPERATING RANGE DISPLAYED	55 ° F TO 85 ° F
SENSOR ACCURACY	± 2 ° F AT 77 ° F
LOW VOLTAGE LIMIT 115 VOLT UNITS	75 VAC
LOW VOLTAGE LIMIT 230 VOLT UNITS	175 VAC
LOW VOLTAGE PROCESSOR RESET	65 VAC
LINE VOLTAGE	115 THROUGH 230 VAC
FREQUENCY	50 OR 60 HZ
FAN OUTPUT	6 AMPS @ 115 VAC
FAN OUTPUT	6 AMPS @ 230 VAC
VALVE OUTPUT	1/4 AMP @ 115 VAC
VALVE OUTPUT	1/4 AMP @ 230 VAC
PUMP OUTPUT	6 AMPS @ 115 VAC
PUMP OUTPUT	6 AMPS @ 230 VAC
HEATER OUTPUT	30 AMPS @ 115 VAC
HEATER OUTPUT	20 AMPS @ 230 VAC
MINIMUM OPERATING TEMPERATURE	0 ° F
MAXIMUM OPERATING TEMPERATURE	180 ° F
MAXIMUM RH CONDITIONS	99 % NON CONDENSING
POWER CONSUMPTION	LESS THAN 5 WATTS

DIMENSIONS

DISPLAY PANEL	5.30" X 4.125"
PANEL CUT OUT	4.20" X 3.375"

CABLE LENGTHS

DISPLAY	15' STANDARD
AIR SENSOR	7' STANDARD
WATER SENSOR	7' STANDARD

Custom cable lengths are available, please specify in 5 ft increments when ordering

SYSTEM INPUTS

1	AMBIENT OR INSIDE AIR TEMPERATURE
1	WATER INLET TEMPERATURE SENSOR
1	OUTSIDE AIR TEMPERATURE SENSOR [OPTIONAL]
1	ALTERNATE AIR TEMPERATURE SENSOR [OPTIONAL]

NOTES: Maximum display cable length is 50 feet. Sensor cable lengths should also be limited to 50 feet. The outside air sensor is an optional item and is not included with the standard control package. The Outside Air Sensor is NOT available when an Alternate Air Sensor is required.

DIGITAL CONTROL DIMENSIONS

NOTE: THE FX-MAXX "HIDEAWAY CONTROL" IS THE SAME AS THE STANDARD FX-MAXX CONTROL WITH ADDITION OF A BEZEL AND DOOR. THE ADDITION OF THE BEZEL PREVENTS THE USE OF A FACE PLATE SENSOR. THEREFORE AN ALTERNATE AIR SENSOR MUST BE INSTALLED WHEN USING THIS DISPLAY.

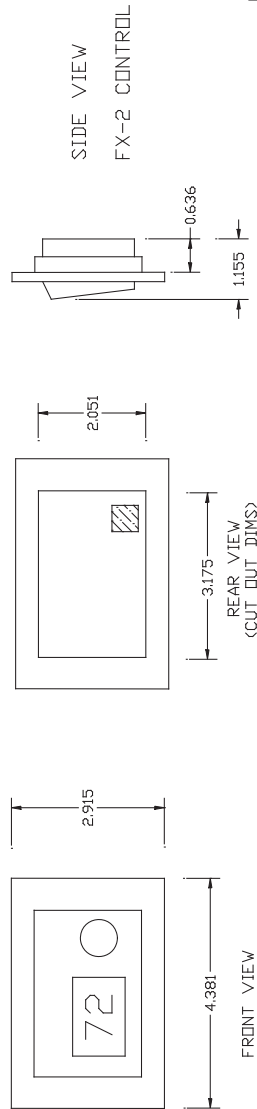
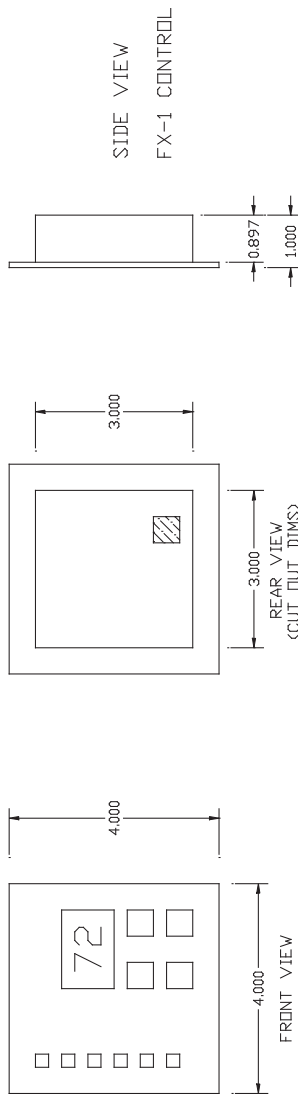
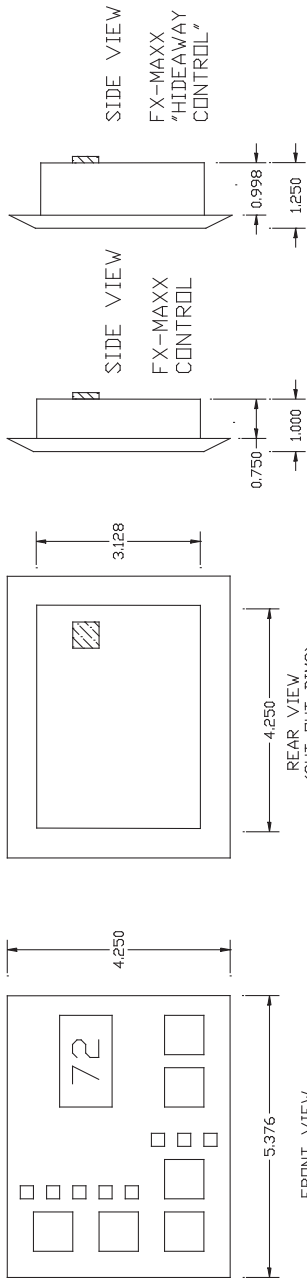

DWG# OE70000A

WIRING DIAGRAM

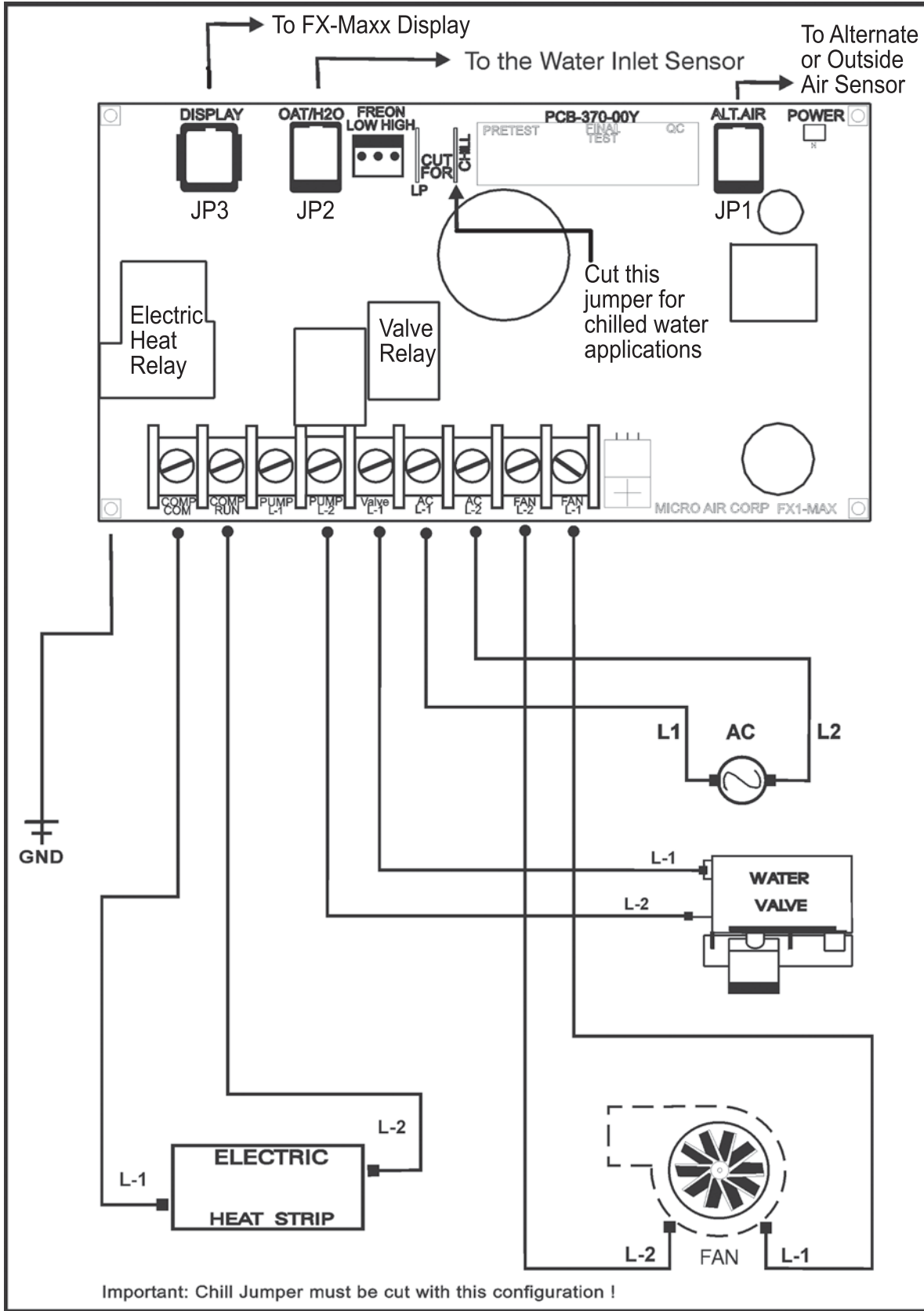

Note: The OAT/H2O jack (JP2) is used for the Water Sensor (H2O) only. The Outside Air Temperature (OAT) designation is for Direct Expansion applications only

INSTALLATION OVERVIEW

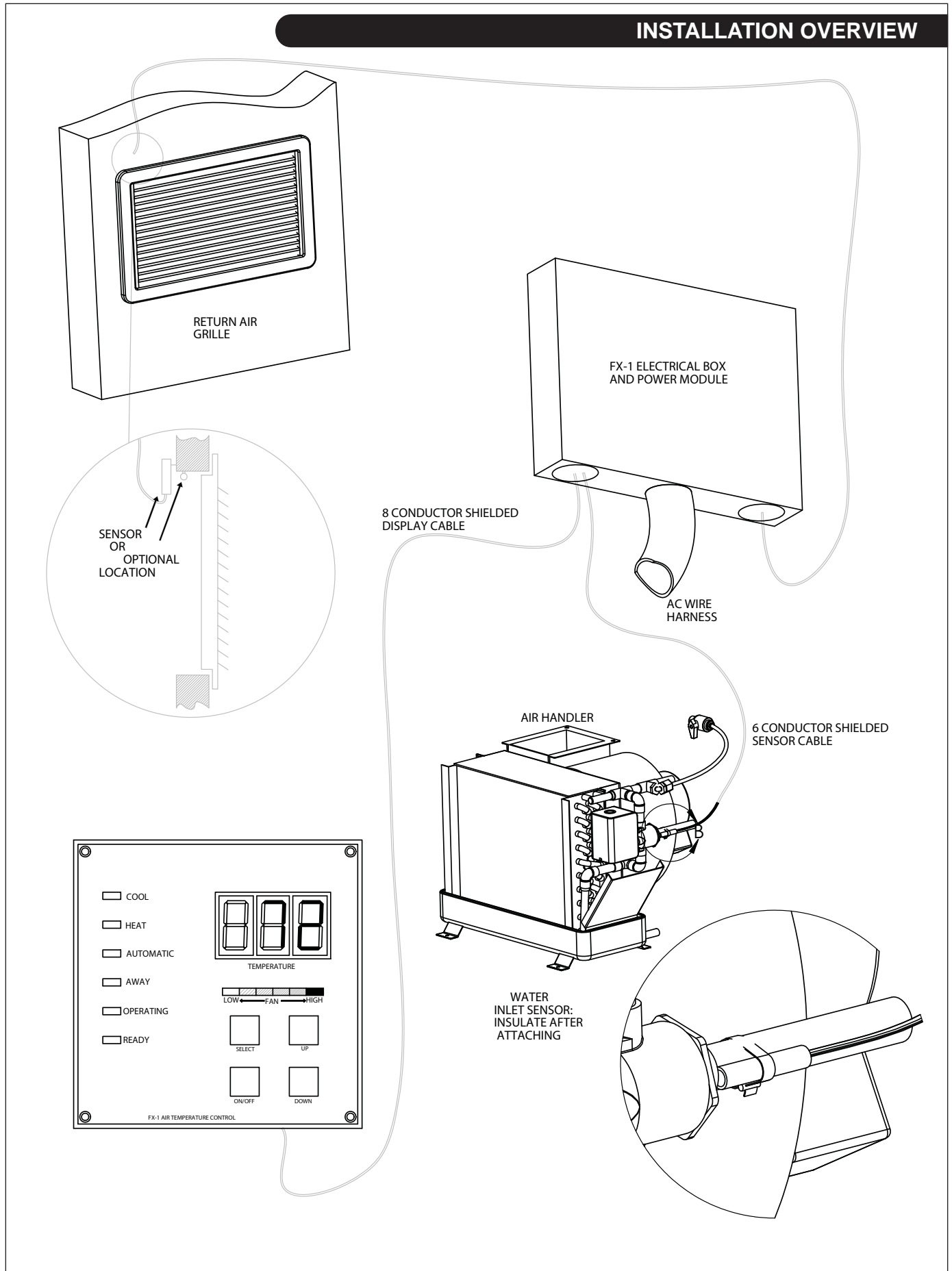

BASIC SYSTEM STARTUP TROUBLESHOOTING

PROBLEM	PROBABLE CAUSE	SOLUTIONS
<ul style="list-style-type: none"> • No lights in the display and the system does not heat or cool. Power on reset does not occur when AC power is applied. 	<ul style="list-style-type: none"> • AC breaker is not turned on or AC power is not available. • Display cable or jacks broken or dirty. • Display cable is improperly assembled. • AC input is less than 75 VAC. 	<ul style="list-style-type: none"> • Check for AC power at circuit breaker. • Check for AC power at module input. • Clean all jacks and plugs. • Try another known good display cable. • Check the system wiring diagram. • Check for proper AC power.
<ul style="list-style-type: none"> • The system operates but there is no water valve and no heat or cool lights. 	<ul style="list-style-type: none"> • The set-point is satisfied! 	<ul style="list-style-type: none"> • Raise or lower the set-point to allow the unit to cycle.
<ul style="list-style-type: none"> • The display toggles between AAA and zero (0), and the system will not run. 	<ul style="list-style-type: none"> • The face plate air sensor is shorted or the display cable has been shorted or damaged. • The face plate air sensor is open or the display cable is broken. 	<ul style="list-style-type: none"> • Clean all plugs and jacks. • Try an alternate air sensor or replace the display with a known good display. • Try a known good display cable. • Check the existing display cable for screws, staples and other damage.
<ul style="list-style-type: none"> • System displays room temperature but there is no fan or water valve. 	<ul style="list-style-type: none"> • Set-point is satisfied and P-13 is programmed to cycle the fan on demand. • See page 10 of this manual. 	<ul style="list-style-type: none"> • Raise or lower the set-point to allow the system to cycle on... Check P-13
<ul style="list-style-type: none"> • The system operates but there is no fan. • The fan runs but only on high speed, lower speeds are not available • The fan runs very slow and is noisy. 	<ul style="list-style-type: none"> • The fan wiring is incorrect. • Ducting is restricted or fan is miswired or triac has failed in closed mode. • Fan triac has failed or motor is defective. 	<ul style="list-style-type: none"> • Check and correct fan motor wiring • Check for proper duct sized, correct any ducting restrictions and check wiring. Return the module for fan output triac or return module for repair or call for service.
<ul style="list-style-type: none"> • System operates but valve and heater outputs appear to be reversed. 	<ul style="list-style-type: none"> • The "Cut for Chill" Jumper has not been cut. 	<ul style="list-style-type: none"> • The "Cut for Chill" Jumper must be cut for the module to function as an air handler control. <p>Note: Do NOT cut the LP Jumper.</p>

STUCK BUTTON CHART

STUCK BUTTON	DISPLAY BEHAVIOR
POWER	From the Off Mode, the control will reset ("888") and the display will go blank. From the On Mode, the display will not reset, ambient temperature is displayed, all outputs work but no buttons function.
SELECT	
UP	
DOWN	

DISPLAY CABLE TROUBLESHOOTING GUIDE

DISPLAY PROBLEM	POSSIBLE CAUSES
No display and the buttons do not work	<ul style="list-style-type: none"> • The cable is assembled backwards • Pin 1 is open • Pin 3 is open
No buttons, no display but the fan is running.	<ul style="list-style-type: none"> • Pin 5 is open
No relays turning on, display is on, buttons operate and fan is running	<ul style="list-style-type: none"> • Pin 2 is open • Pin 1 and Pin 2 are shorted • Pin 4 is open
No fan output	<ul style="list-style-type: none"> • Pin 6 is open
All relays are on, no fan operation and no display	<ul style="list-style-type: none"> • Pin 2 is shorted to pin 3

WARRANTY INFORMATION

The Limited Warranty applies to the following product lines: TECHNICOLD Air Conditioning and Refrigeration Products
Technicold manufacturer NORTHERN LIGHTS, INC. (herein "NLI") extends to the purchaser and user (herein "Owner") of the product the following limited warranty (herein "Warranty"). Please read it carefully.

Technicold Air Conditioning and Refrigeration Products	
Warranty Period	
Product	12 Months
Parts and Labor	12 Months
Parts	24 Months

NLI'S WARRANTY AND RESPONSIBILITIES

Subject to the terms and conditions set out below, NLI warrants the product and its factory installed parts to be free from defects in material and workmanship under normal use and service.

If the product is purchased for and used primarily in a commercial endeavor, the Warranty period shall extend from the date of delivery to the original end user for a period of twelve (12) months with no limit on hours of use. If the product is purchased for and used primarily in personal, family or household use, the warranty period shall extend from the date of delivery to the original end user for a period of twelve (12) months with no limit on hours of use. Original parts shall be warranted for a period of twenty-four (24) months from date of delivery.

The obligation of this Warranty shall be limited to repairing or replacing any part of the product which NLI agrees is defective in materials or workmanship under normal use and service during the warranty period.

If during the warranty period the product or any of its parts are found to be defective because of workmanship or materials, it will be repaired or replaced without charge if the Owner prepays the transportation charges and returns the item to NLI's authorized warranty dealer. To find the location of the nearest NLI authorized warranty dealer, contact NLI at the address, e-mail address, or telephone or fax numbers in this publication.

Upon request by the Owner and agreement by NLI, repair of product or replacement of parts under this Warranty may be completed at a place other than at an NLI authorized warranty dealer. See "Owner's Responsibilities".

NLI'S WARRANTY AND RESPONSIBILITIES

Within thirty (30) days of purchase, Owner or authorized agent of Owner must complete, sign and deliver to NLI the Warranty Registration Card in order to validate this warranty. Owner must break in unit as described in the "Operating Procedures" section of the Operator's Manual.

At the time of presentation of product for service under this Warranty, the Owner or authorized agent must present evidence of the date of original purchase of the product.

If pre-approved repair of product or replacement of parts under this Warranty is completed at a place other than an NLI authorized warranty dealer, Owner shall pay NLI's or its authorized dealer's reasonable travel expenses.

Owner shall pay costs of any labor required to remove and reinstall the product and/or parts thereof, any premium for overtime labor requested by the Owner and costs for transporting the product and/or parts thereof to and from the place where warranty work is performed.

WARRANTY LIMITATIONS

This warranty will not apply to equipment put into service more than twenty-four (24) months from date of shipment from factory, and will not apply in any country with which trade is restricted or banned by the U.S. Department of State, at or after the time of sale or claim.

If the product is used primarily in a commercial endeavor, neither NLI nor any company affiliated with NLI will be liable for general damages, including bodily injuries, except as set forth above, or for incidental consequential damages, including, but not limited to, loss of use, loss of profits, loss of production, expense of substitute equipment or other commercial loss or for damage to property in which equipment is installed. The same limitations shall apply to a product used for personal purposes with respect to all non-personal injuries, general, incidental and consequential damages.

Some countries or states do not fully allow the above exclusions or limitations of general, incidental or consequential damages, so the above exclusions or limitations may not apply to you.

This Warranty extends only to the original parts, accessories and products.

This Warranty is transferable to a new Owner during the warranty period. No transfer forms or fees are required.

This Warranty does not extend to failure resulting from an accident or disaster or from Owner or operator abuse or neglect (such as operating without proper maintenance of equipment, including pumps, filters and electrical connections.)

Service parts worn out by usage and not due to defects in workmanship or material are not covered by this Warranty.

NLI is not responsible for failure resulting from improper repair or use of defective parts or parts not approved by NLI.

NLI is not responsible for failure of product or parts resulting from improper installation or unauthorized modifications.

NLI is not responsible for failure caused by negligent handling or abuse in installation or storage in improper environment which results in corrosion or freezing damage to equipment.

NLI is not responsible for failure caused by any third party's transportation damage to NLI's product.

NLI is not responsible for damage if any warning alarm system is ignored.

NO REPRESENTATIONS AND LIMITATIONS OF IMPLIED WARRANTY

This written Warranty is in lieu of all other express warranties, obligations or limitations. If this equipment is used primarily in a commercial endeavor, no implied warranty, including that of merchantability and fitness for a particular purpose is extended. If the product is used primarily in personal, family or household use, any implied warranty, including that of merchantability and fitness for a particular purpose, shall be limited to twelve (12) months.

Some countries or states do not allow limitations on

how long an implied warranty lasts, so the above limitations may not apply to you.

No person is authorized to make any representations or promised on behalf of NLI or to modify the terms or limitations of this Warranty in any way except in writing and signed by an authorized employee of NLI.

This warranty gives you specific legal rights, and you may have additional statutory rights which vary from one country or state to another.

FX-MAXX CONTROL WITH UV LAMP

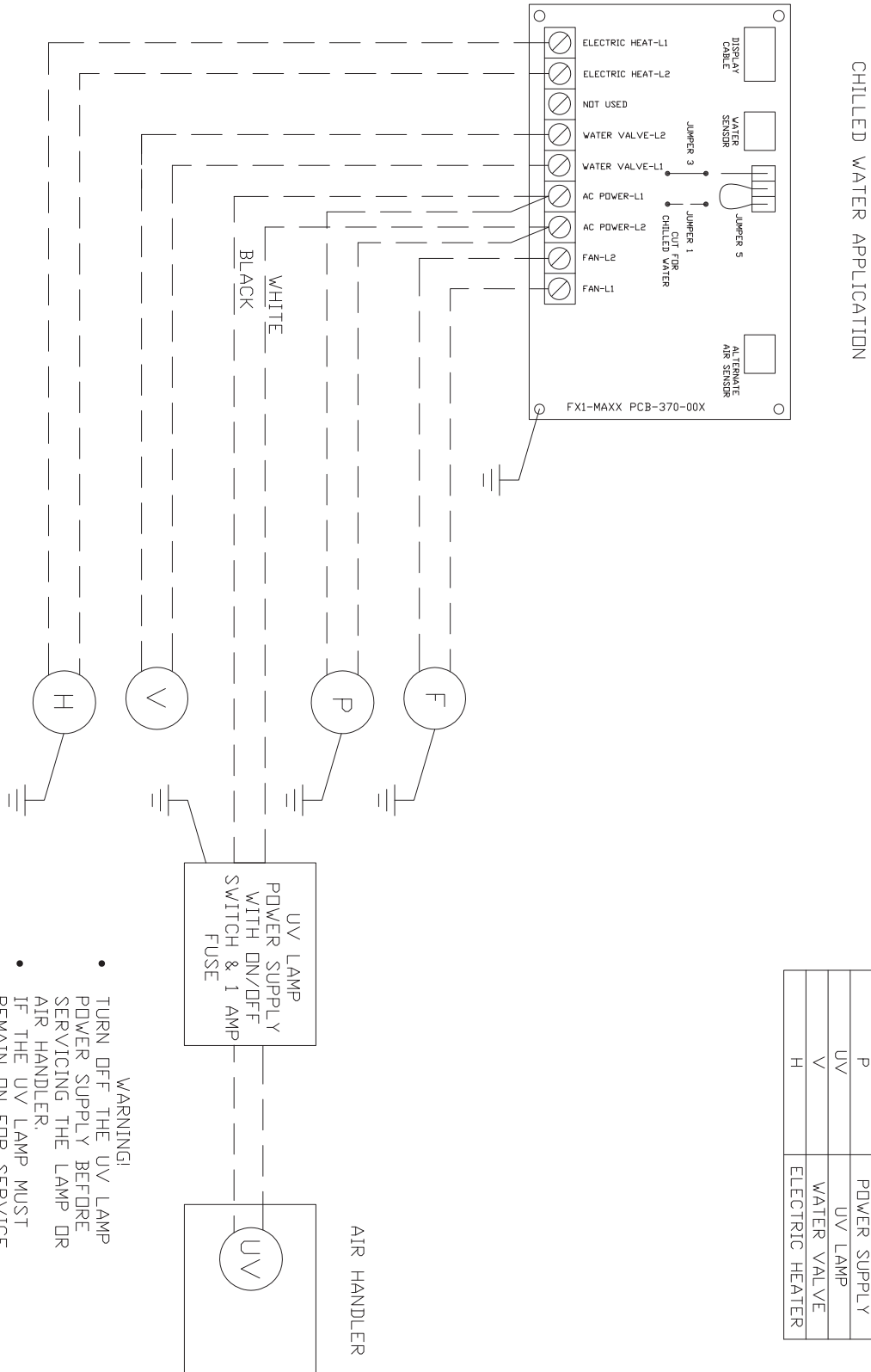

- WARNING!**
- TURN OFF THE UV LAMP POWER SUPPLY BEFORE SERVICING THE LAMP OR AIR HANDLER.
 - IF THE UV LAMP MUST REMAIN ON FOR SERVICE USE APPROPRIATE EYE AND SKIN PROTECTION.
 - TURN OFF UV LAMP POWER SUPPLY BEFORE REMOVING AND CLEANING AIR FILTER. USE ONLY THE AIR FILTER SUPPLIED WITH THE UV LAMP APPLICATION.

FX-MAXX DISPLAY WITH FX-2 CIRCUIT BOARD

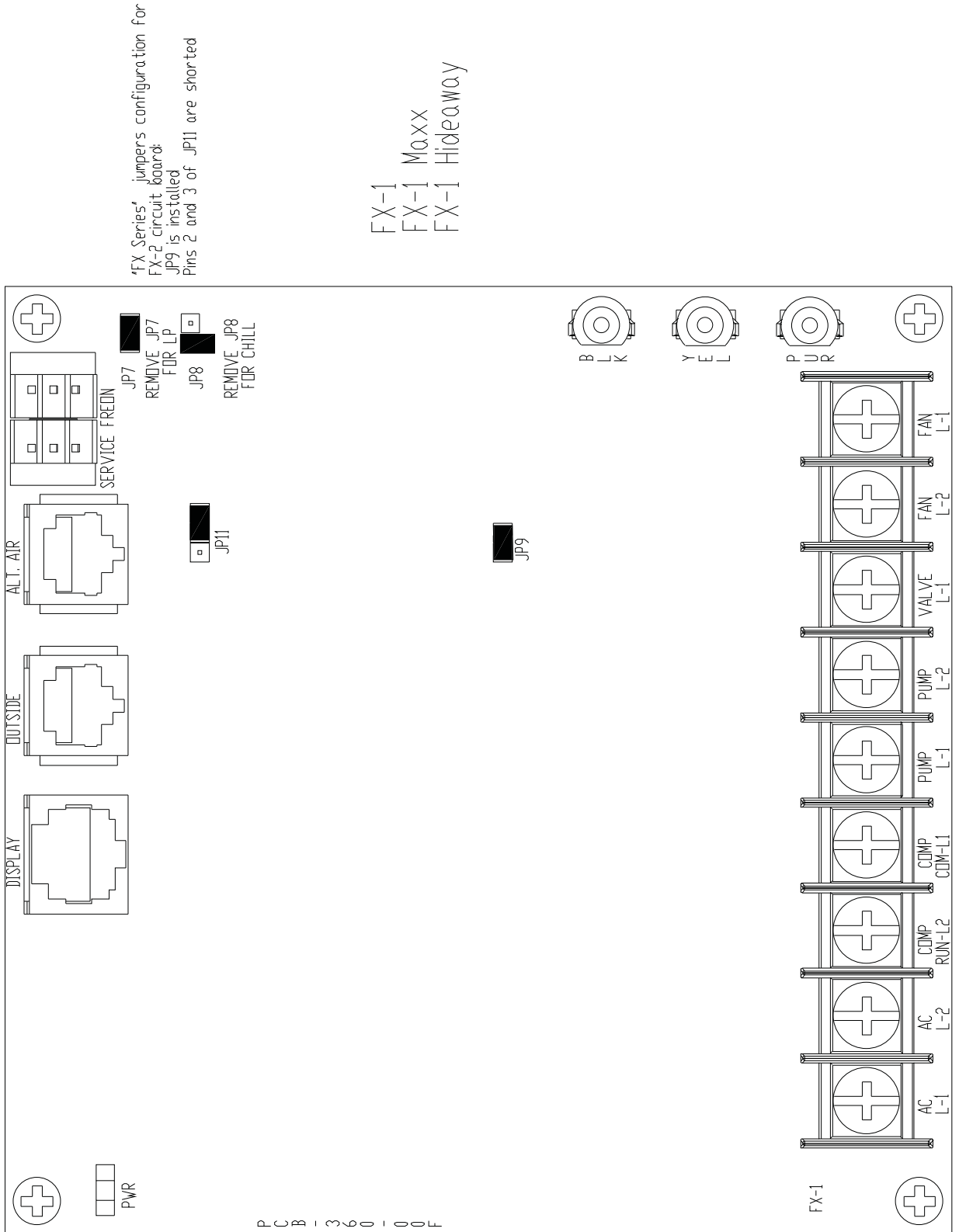

FX Series jumpers configuration for FX-2 circuit board: JP9 is installed Pins 2 and 3 of JP11 are shorted

FX-1
FX-1 Maxx
FX-1 Hideaway

PCB 1360100E



1419 W. Newport Center Drive, Deerfield Beach, FL 33442

Tel: (954) 421-1717 • Fax: (954) 421-1712

Northern Lights and Technicold are registered trademarks of Northern Lights, Inc.

© 2012 All rights reserved. Litho USA. OTCW-FXM